

GHHP-2019-045

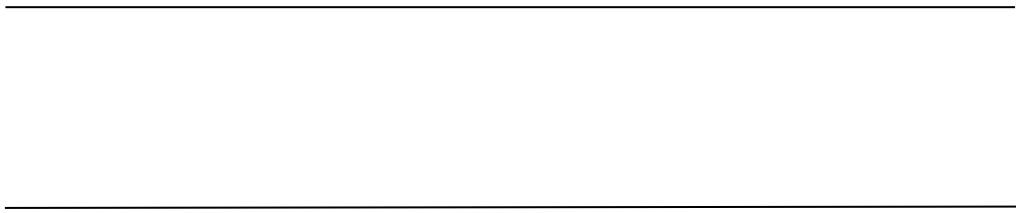



---

1	.....	1
2	.....	4
2.1	.....	4
2.2	.....	6
2.3	.....	6
2.4	.....	6
3	.....	7
3.1	"      "      .....	7
3.1.1	.....	7
3.1.2	"      "      .....	8
3.2	.....	11
3.3	.....	11
3.3.1	.....	11
3.3.2	.....	17
3.3.3	.....	19
3.3.4	.....	20
3.4	.....	21
3.4.1	.....	22
3.4.2	.....	22
3.5	.....	22
4	.....	27
4.1	.....	27
4.1.1	.....	27
4.1.2	.....	29
4.1.3	.....	32
4.1.4	.....	32
4.2	"      "      .....	33
4.2.1	"      "      .....	33
4.2.2	"      "      .....	33
5	.....	37
5.1	.....	37
5.1.1	.....	37
5.1.2	.....	37
5.2	.....	38
5.2.1	.....	38
5.3	.....	39
5.3.1	.....	3
9	.....	
5.3.2	.....	42
6	.....	45
6.1	.....	45
6.2	.....	45
6.3	.....	46

---

	6.4	.....	46
7		.....	48
	7.1	.....	48
	7.2	.....	49
	7.2.1	.....	49
	7.2.2	.....	49
	7.3	.....	49
	7.4	.....	50
8		.....	51
	8.1	.....	51
	8.2	.....	51
	8.3	.....	51
	8.4	.....	52
	8.5	.....	52
9		.....	56
	9.1	.....	56
	9.2	.....	56
	9.2.1	.....	56
	9.2.2	.....	68
10		.....	74
	10.1	.....	74
	10.2	.....	74
	10.3	.....	74
	10.4	.....	75
	10.5	.....	75
	10.5.1	.....	75
	10.5.2	.....	75
	10.6	.....	76
	10.7	.....	76
11		.....	81
	11.1	.....	81
	11.1.1	.....	81
	11.1.2 "	"	81
	11.1.3	.....	81
	11.1.4	.....	82
	11.1.5	.....	82
	11.1.6	.....	83
	11.2	.....	85

---

		[20
	12] 3	
		[2012]8
		[2014]2
		[2015]7
		[2016]17

1	
2	
3	

1	" "
---	-----

---

1

( )

) ( ) ( ) [ ( ) ]

2002 6

" PVC "

2003 1

" PVC "

2005 8 31

2003 12

" "

2005 1

2005 8 31

2009 6

" "

[2009]100

2014 1

2014 1 29

[2014]005

57000

186671

2012 10 31

---

[2012] 3 2012 9

2012 10 26

[2012]8

E101 E201 E301

" + +15

" " + " " +

+MBR "

2014 1

---

682

<

> ( [2017]4

2019 2

2019 3 2

2019 3 21 22

---

# 2

## 2.1

1 1989 12 26  
2014 4 24

2015 1 1

2 1984 5 11  
1996 5 15 200

8 2 28 2017 6 27 2018 1 1

3 1987 9 5  
1995 8 29

2000 4 29 2015 8 29 201

6 1 1 2018 10 26

4 1996 10 29

1997 2018 12 29

5 1995 10 30  
2004 12 2

9 2013 6 29 2015 4 24

---

11 23

8

2018 5 16

2012 1 12

2018 3 28

2018

5 16

9

2009 9 23

2012 1 12

2017 6 3

2018 3 28

2018 5 16

10

1998 11 29

253

2017 7 16

682

2017 10 1

11

<

>

[2017]4

12

[2017]1235

13

[2015]113

14

[2

018]34

15

[97]122

16

[2018] 6

17

[201

5]256

---

## 2.2

1

2012 9

2 <

> [201

2]8 2012 10 26

3

2015 5

4 <

> [20

15]7 2015 8 4

## 2.3

1

HJ792-201

6

2 < >

2018 9 2018 5 15

3

HJ/T 397-2007

4

HJ/T 91-2002

5

HJ 819-2017

## 2.4

1

2

2016 5

3

---

# 3

## 3.1 " "

### 3.1.1

1 PVC

2003 1

" PVC "

2005 8 31

2

2003 12 "

"

2005 1

2005 8 31

3

2009 6 "

"

[2009]100

2014 1

2014 1 29

[2014]005

4

2017 10 "

"

[2017]99

2017 11

2018 12

3-1

---

3.1.2

“

”

3-1

1	PVC	PVC 100 /a	2003 1 14	2002 6	2005 8 31
2		5000 /a	2003 12 22	2004 1 2005 1	2005 8 31
		2000 /a			
		50 /a			
		1000 /a			
		500 /a			
3		A 3000 /a	2009 6 4	2009 7 2014 1	2014 1 29 [2014]005
		B, 2500 /a			
		C, 1500 /a			
		D, 1500 /a			
		A, 400 /a			
		B, 500 /a			
		C, 500 /a			
		D, 200 /a			
		A 100 /a			

		B, 100 /a				
4		4.8 /a	2017 10 27  [2017]99	2017 11 2019 4		
		3.2 /a				
		3.2 /a				
		2.0 /a				
		10.8 /a				
		6.0 /a				
		10.0 /a				

---

## 3.2

99

118° 88' 65"

32° 14' 05"

3

E101 E201



	15	500
	980	15kg 260kg
201 E301		E101 E

3-3

			h
	100 /a		2000
	100 /a		
	200 /a		
	100 /a		
	200 /a		
	30 /a		
	300 /a		
	300 /a		
	50 /a		
	100 /a		
	5kg/a	E201	
	5kg/a	E101	
	5kg/a		
	10kg/a	E301	
	250kg/a		



---

---

--	--	--	--	--

					/
		+	+ + MBR	+ MBR	
			" "	" "	
					/
		31047m <sup>2</sup>			/

### 3.3.2

3-5

3-5

		/			
1		RET B S 25	1	1	/
2		EURO-ST D S25	1	1	/
3		T18BS25	1	1	/
4		YB-2	1	1	/
5		PL303	3	3	/
6		ZB-1E	1	1	/
7		FT-200AE	2	2	/
8		ZS-2E	1	1	/
9		HB43-S	1	1	/
10		/	1	1	/
11		YP10K-1	2	2	/
12		PL602-L	1	1	/
13		LGJ-50PLC	1	1	/
14		DP30A	1	1	/
15		DHG-9203A	1	1	/
16		HS-20D	1	1	/
17		UNI LAB-05- TJ	1	1	/

18

		/			
21		Agilent 1200	1	1	/
22		LC-20A	10	10	/
23		Agilent1260	20	5	/
24		XP205DR	2	2	/

2

/			
HWCL-5	1	1	/
DJ-1	4	4	/
SHB-	1	1	/
R201D	2	2	/
/	2	2	/
R201D	2	2	/
SHB-	1	1	/
ZKC-A	1	1	/



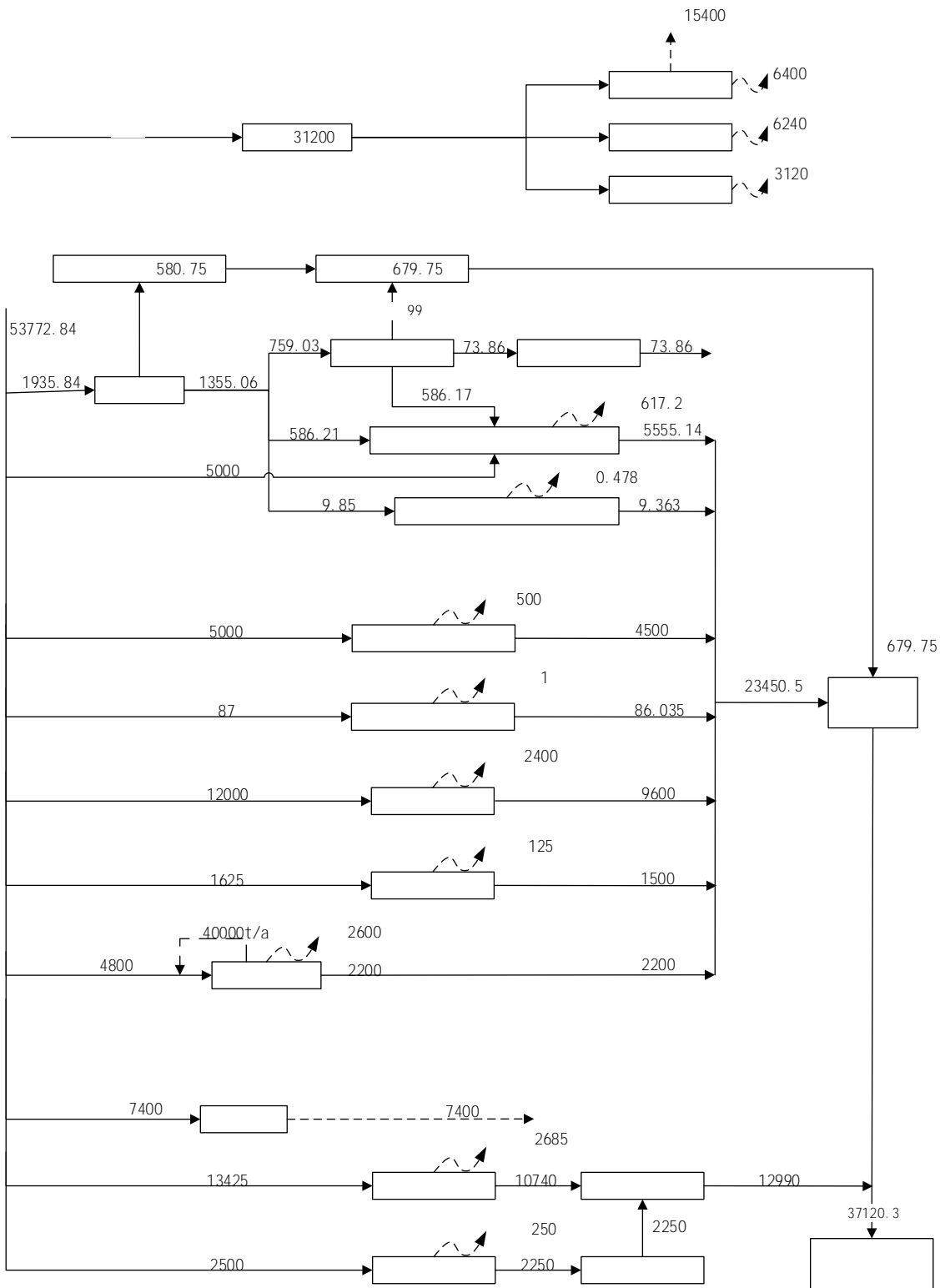

3-1

t/a

### 3.4

E101 E201 E301



---

3

100t/d

150t/d

MBR

6

MBR

100t/d

150t/d

37120.3t/a

3-7

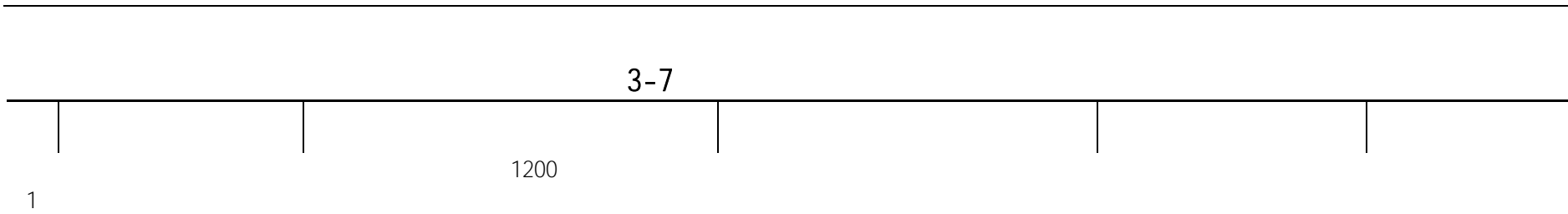

---

[2018]6

2.

[2015]256

3-8

3-9

3-8

---

[2018]6

50%

1





4-1

					t/a			
					10054.8			
			COD SS		95.398			
					9600			
			pH COD SS		500			
			COD SS		679.75			
			COD SS		10740			
			COD SS		2250			

---

## 4.1.2

3

1 30

1

4-2

4-2

4-2

					/		/	
							90%	30
							60%	10cm

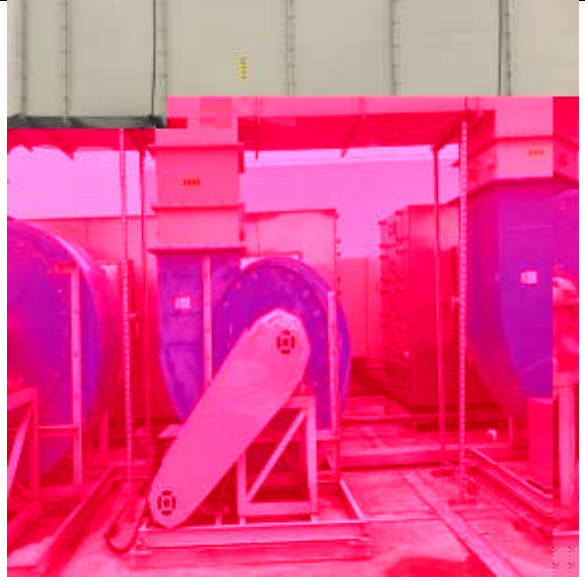

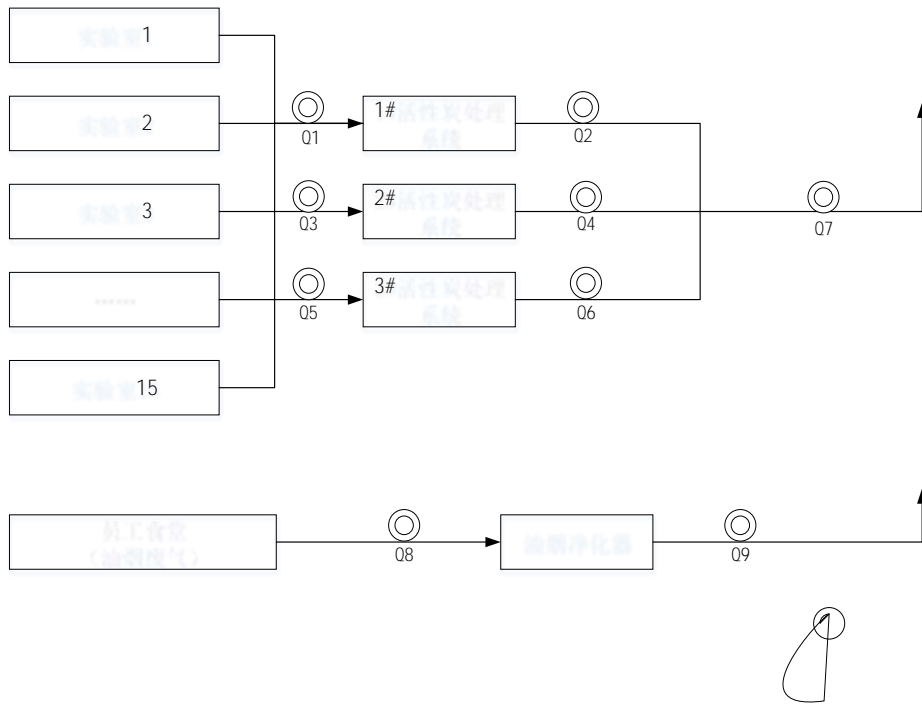

4-2

---

### 4.1.3

---

4-4

4-4

			/			t/a			
				HW49					
				900-					
				047-					



4-5

		pH COD SS	+	+ +MBR	+ +MBR	580	
				+ +	+ +	155	
		HCL				205	
						5	
						0	
						5	
						5	

						10	
						10	
					[97]122		
						1075	

---

5

5.1

5.1.1

5.1.2

1

2

3

4





" + +15  
"

---

280

5.7

6

500

980

15kg

260kg

1

"

"



GB18597-2001)

5

2

6

100m

7

(GB12532-90)

15

8

DB32139-96)

---

24733t/a, COD 7.35t/a SS 6.15t/a  
 0.36t/a 0.06t/a, COD 2.47t/a SS 1.73t  
 /a 0.36t/a 0.01t/a, 0.006  
 t/a 0.006t/a 0.08kg/a HCl 0.03kg/a 0.025k  
 g/a

" "

5

### 5.3.2

2012 8 )

1

186671m

60000m )



---

(GB18597-2001)

5

50

6

( [97]122

7

24739

COD 7.35

NH<sub>3</sub>-N 0.36

COD

2.47

NH<sub>3</sub>-N 0.36

" "

3

5

"

2012 8 "

---

6

6.1

6-1

6-1

	mg/L, pH	
pH	6-9	
	500	
	400	
	35	
	3.0	

6.2

3

1 30

2

0

200

5

### 6-2

	(kg/h)			(mg/m <sup>3</sup> )	
	(mg/m <sup>3</sup> )	H <sub>1</sub> =30m	H <sub>2</sub> =30m		
	190	29	14.5	12	GB16297-1996 2
	100	1.4	0.7	0.20	
	261	0.3	/	/	

GB16297-1996

200m

5m

50%

H<sub>1</sub>=30m

H<sub>2</sub>=30m

50%

### 6-3

	mg/m <sup>3</sup>	%			
	2.0	60	75	85	GB18483-2001

### 6.3

GB1234

8-2008 3

### 6-4

### 6-4

	Leq dB A	
	65	GB12348-2008 3
	55	

### 6.4

[2012]8

[2015]7

### 6-5

6-5

		24739 t	24739 t
	COD	7.35 t/a	2.47 t/a
	SS	6.15 t/a	1.73 t/a
		0.36 t/a	0.36 t/a
		0.06 t/a	0.01 t/a
		0.006 t/a	0.006 t/a
		0.006 t/a	0.006 t/a
		0.08 kg/a	0.08 kg/a
		0.03 kg/a	0.03 kg/a
		0.025 kg/a	

---

# 7

E101 E201 E301

## 7.1

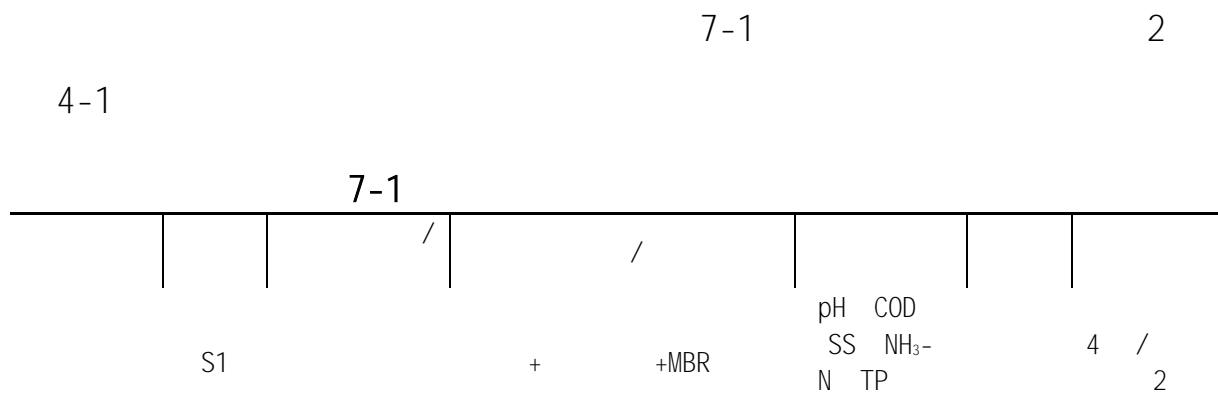

---

7.2

7.2.1

VOCs

7-2

2

4-2

7-2

---

		/		/			
--	--	---	--	---	--	--	--

---

7-3

/



---

8-5

8. 8.

8.

0.5dB

0.5dB

8. 0B823480)95ETQq0.000071 0 595.32 841.92 reW\*nBT/F

8-1

					/
	pH	pH	GB/T6920-1986	/	pH PHB-1 JSGHEL-YQ-112-2
	COD <sub>Cr</sub>		HJ 828-2017	4 mg/L	50mL JSGHEL-YQ-115-2
	SS		GB/T11901—1989	0.4 mg/L	BSA224S JSGHEL-YQ-102
			HJ 535-2009	0.025 mg/L	UV201 JSGHEL-YQ-38
			GB 11893-1989	0.01 mg/L	UV201 JSGHEL-YQ-38
			HJ 637-2018	0.06 mg/L	JLBG-125 JSGHEL-YQ-35
			HJ/T 33-1999	2 mg/m <sup>3</sup>	Trace 1300 JSGHEL-YQ-37
			HJ 549-2016	0.03 mg/m <sup>3</sup>	ICS-600 JSGHEL-YQ-135-2
		- / -	HJ 734-2014	0.01mg/m <sup>3</sup>	Trace 1300 JSGHEL-YQ-37
	VOCs	- / -	HJ 734-2014	0.001 0.01mg/m <sup>3</sup>	Thermo Trace 1300 JSGHEL-YQ-51 YQ3000-C JSGHEL-YQ-160-2
			GB 18483-2001	/	JLBG-125 JSGHEL-YQ-35 YQ3000-C JSGHEL-YQ-160-2 YQ3000-C JSGHEL-YQ-160-3
			GB12348-2008	/	AWA6228 JSGHEL-YQ-121-3

---

8-2

%

%

## 8-4

		mg/L	mg/L	
pH	/	/	/	/
CODcr	GSB 07- 3161-2017200197	169± 9	172 164	
	GSB 07- 3161-20172001108	50.7± 3.0	51.8 49.2	
SS	/	/	/	/

# 9

JSGHEL20192

01 JSGHEL2019201

## 9.1

2019 3 21 2019 3 22

" "

## 9.2

### 9.2.1

9.2.1.1

2019 3 21 2019 3 22

S1

S2 S3

S1

pH7.3

2 7.41 COD<sub>Cr</sub>167mg/L 5.61mg/L 0.54mg/L 35mg/L

L

9-1

9-1

				(mg/L)	
2019 3 21	S1	pH	7.32		

			(mg/L)		
2019 3 22			0.54	3.0	
			35	400	
			2.10	/	/
	S2	pH	7.51	/	/
		COD <sub>Cr</sub>	12	/	/
			9	/	/
	S3	pH	7.60	/	/
		COD <sub>Cr</sub>	16	/	/
			6	/	/
	S4	pH	7.63 7.67	/	/
		COD <sub>Cr</sub>	4.148× 10 <sup>3</sup>	/	/
			0.563	/	/
			0.06	/	/
			84	/	/
	S5	pH	7.44 7.46	/	
		COD <sub>Cr</sub>	42	/	/
			0.111	/	/
			0.02	/	/
			6	/	/
S1	pH	7.35 7.43	6 9		
	COD <sub>Cr</sub>	167	500		
		4.40	35		
		0.47	3.0		
		35	400		
		45.9	/	/	
	S2	pH	7.47	/	/
		COD <sub>Cr</sub>	14	/	/
			8	/	/

			(mg/L)		
S4	pH	7.56 7.61	/	/	
	COD <sub>Cr</sub>	2.837× 10 <sup>3</sup>	/	/	
		1.36	/	/	
		0.10	/	/	
		75	/	/	
S5	pH	7.42 7.45	/	/	
	COD <sub>Cr</sub>	40	/	/	
		0.074	/	/	
		0.02	/	/	
		8	/		

2019 3 22

S3

9.2.1.2

2019 3 21

2019 3 22

GB16297-1996 2

GB18483-2001

9-2

9

-3

9-2

1#	2019 3 21	mg/m <sup>3</sup>	ND	ND	ND	ND	/	/	
		kg/h	<5.72× 10 <sup>-4</sup>	<5.95× 10 <sup>-4</sup>	<5.60× 10 <sup>-4</sup>	<5.95× 10 <sup>-4</sup>	/	/	
		(mg/m <sup>3</sup> )	ND	ND	ND	ND	/	/	
		(kg/h)	<3.81× 10 <sup>-2</sup>	<3.97× 10 <sup>-2</sup>	<3.73× 10 <sup>-2</sup>	<3.97× 10 <sup>-2</sup>	/	/	
		(mg/m <sup>3</sup> )	0.13	0.10	0.05	0.13	/	/	
		(kg/h)	2.42× 10 <sup>-3</sup>	1.92× 10 <sup>-3</sup>	9.95× 10 <sup>-4</sup>	2.42× 10 <sup>-3</sup>	/	/	
		# (mg/m <sup>3</sup> )	16.2	24.1	10.1	24.1	/	/	
		# (kg/h)	0.309	0.479	0.188	0.479	/	/	
	Q1		mg/m <sup>3</sup>	ND	ND	ND	ND	/	/
			kg/h	<5.41× 10 <sup>-4</sup>	<5.52× 10 <sup>-4</sup>				

2019  
3 22



2#  03	3 21	kg/h	$<4.24 \times 10^{-4}$	$<4.18 \times 10^{-4}$	$<4.40 \times 10^{-4}$	$<4.40 \times 10^{-4}$	/	/
		(mg/m <sup>3</sup> )	ND	ND	ND	ND	/	/
		(kg/h)	$<2.83 \times 10^{-2}$	$<2.79 \times 10^{-2}$	$<2.94 \times 10^{-2}$	$<2.94 \times 10^{-2}$	/	/
		(mg/m <sup>3</sup> )	0.05	0.01	ND	0.05	/	/
		(kg/h)	$<7.06 \times 10^{-4}$	$<2.32 \times 10^{-4}$	$<1.47 \times 10^{-4}$	$<7.06 \times 10^{-4}$	/	/
		<sup>#</sup> (mg/m <sup>3</sup> )	0.443	0.509	0.440	0.509	/	/
		<sup>#</sup> (kg/h)	$6.27 \times 10^{-3}$	$7.10 \times 10^{-3}$	$6.46 \times 10^{-3}$	$7.10 \times 10^{-3}$	/	/
	2019 3 22	mg/m <sup>3</sup>	ND	ND	ND	ND	/	/
		kg/h	$<4.12 \times 10^{-4}$	$<4.32 \times 10^{-4}$	$<4.14 \times 10^{-4}$	$<4.32 \times 10^{-4}$	/	/
		(mg/m <sup>3</sup> )	ND	ND	ND	ND	/	/
		(kg/h)	$<2.75 \times 10^{-2}$	$<2.88 \times 10^{-2}$	$<2.76 \times 10^{-2}$	$<2.88 \times 10^{-2}$	/	/
		(mg/m <sup>3</sup> )	0.08	0.10	0.10	0.10	/	/

---

---

--	--	--	--	--	--	--	--	--	--







---

---

	09			0.17	0.08	0.17	0.17	0.13	0.14	2.0
--	----	--	--	------	------	------	------	------	------	-----

9.2.1.3

2019 3 21      2019 3 22

59.3dB(A)

GB12348-2008 3

9-4

9-5

9-4

				dB(A)	dB(A)		
2019 3 21	Z1	1		55.5	65		
	Z2	1		59.3	65		
	Z3	1		52.3	65		
	Z4	1		52.3	65		
	Z5	1		52.0	65		
	Z6	1		55.8	65		
2019 3 22	Z1	1		59.1	65		
	Z2	1		56.4	65		
	Z3	1		51.9	65		
	Z4	1		51.9	65		
	Z5	1		51.0	65		
	Z6	1		53.2	65		

9-5

			%	kPa	m/s	
2019 3 21		/	/	/	2.4	
2019 3 22		/	/	/	2.1	

9.2.1.4

1

37120.3t/a COD 6.

---

20 t/a

1.30t/a

0.21t/a

0.02t/a

9-6

9-6

		mg/L	t/a	t/a	
		/	37120.3	24733	
	COD <sub>cr</sub>	167	6.20	7.35	
	SS	35	1.30	6.15	
		5.61	0.21	0.36	

---

		1#	VOCs
61.3%-95.2%	2#	VOCs	17.0%-71.
1% 3#	VOCs	40.4%-80.7%	
	5.56%-55.5%		
		9-7	
	9-8		

---

9-7

kg/h

2019 3 21

2019 3 22



---

2019 3 21

2019 3 22

9.2.2.2

2019 3 21      2019 3 22

,

98.6%-99.0%

89.3%-92.9%

80.3%-94.65

66.7%-80%

9-9

9-9

mg/L

2019 3 21	S4	4.148× 10 <sup>3</sup>	84	0.563	0.06
	S5	42	6	0.111	0.02
%		99.0	92.9	80.3	66.7
2019 3 22	S4	2.837× 10 <sup>3</sup>	75	1.36	0.10
	S5	40	8	0.074	0.02
%		98.6	89.3	94.6	80

---

10

10.1

" "

10-1

---

10.4

10.5

10.5.1

10.5.1.1

115m

115m

10.5.1.2

10.5.2

10.5.2.1

2019 1 14

3

1



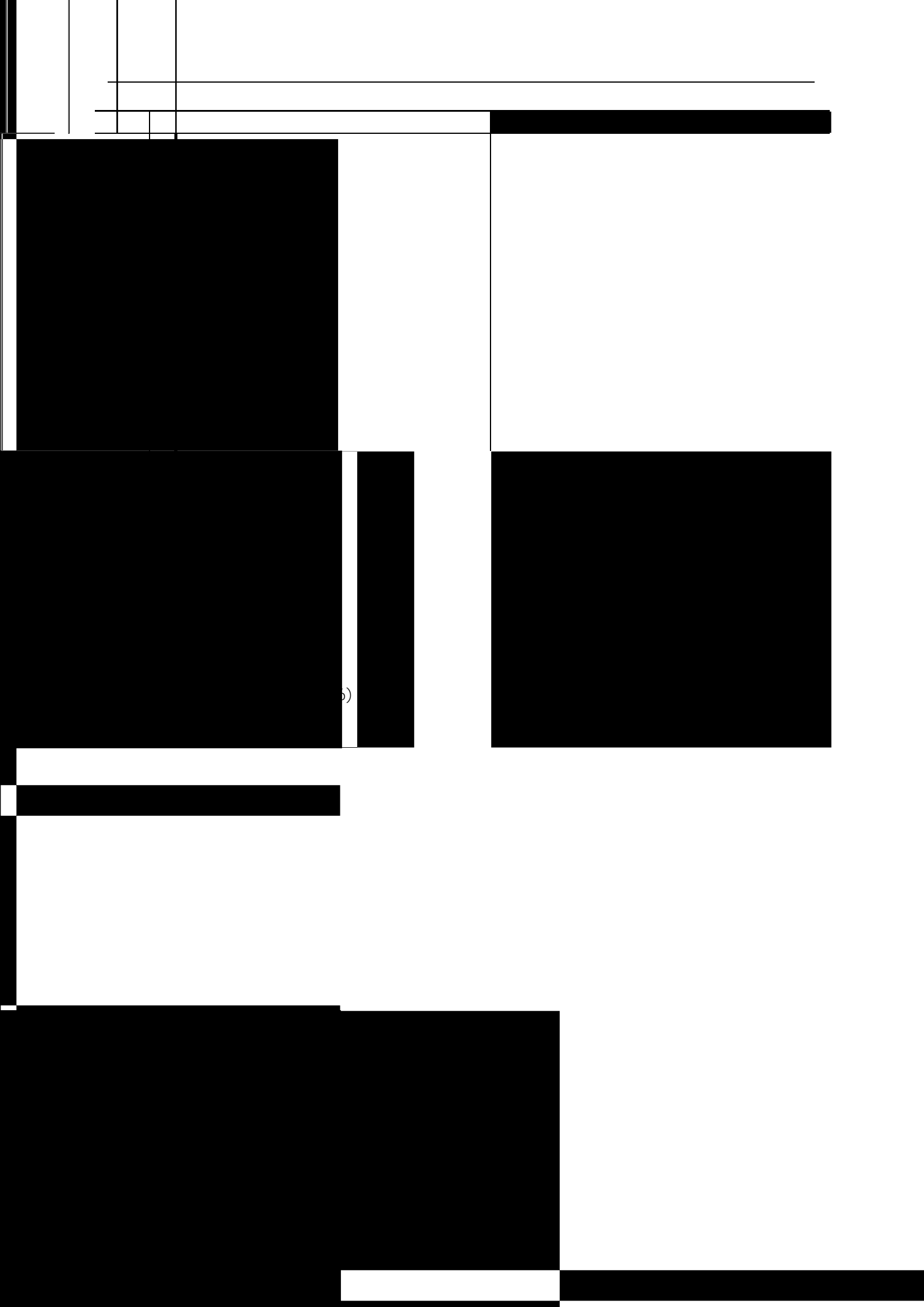

	GB18597-2001)	
5	2	5 1 2 1 3 1
6	(GB12532-90) 15	
7	DB32139-96)	
8	24733t/a, COD 7.35t/a SS 6.15t/a 0.36t/a 0.06t/a, COD 2.47t/a SS 1.73t/a 0.36t/a 0.01t/a, 0.006t/a 0.006t/a 0.08kg/a HCl 0.03kg/a 0.025kg/a	37120.3 NH <sub>3</sub> -N 0.21 1.3 COD 6.20 0.02 0.020kg/a

10-3

"

"

186671m

1 60000m )

D201

E101 E201 E301

155597m<sup>2</sup>,

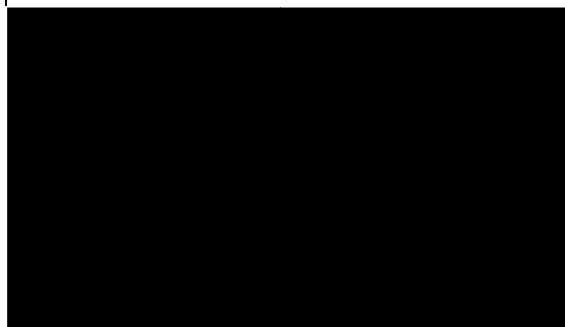

	12.2 m <sup>2</sup> )		E301	
	31074m <sup>2</sup> ,	7.4 m <sup>2</sup> )	20	2016 6
2	"	"	"	"
	+	+MBR		+

8	(GB18597-2001)	(GB18597-2001)
9	50	50
10	( [97]122	( [97]122
11	24739 COD 7.35 NH <sub>3</sub> -N 0.36 COD 2.47 NH <sub>3</sub> -N 0.36	37120.3 COD 6.20 NH <sub>3</sub> -N 0.21 1.3 0.02

---

11

11.1

11.1.1

99

186671

90300

935

500

980

15kg

260kg

11.1.2 "

"

2012 9

2012 10 26

2015 5

2015 8 4

2013

2015 12

¢



---

4

### 11.1.6

1

			S1		p
H7.32	7.41	COD <sub>Cr</sub> 167mg/L	5.61mg/L	0.54mg/L	35m
g/L					

2

GB16297-1996

2

GB1848

3-2001

3

59.3dB(A)

---

1

37120.3t/a COD 6.

20 t/a

1.3t/a

0.21t/a

0.02t/a



" "

( )

( )

( )

				/		99
( )		C2720			/	118° 88' 65" 32° 14' 05"

500